

LM3526

Dual Port USB Power Switch and Over-Current Protection

General Description

The LM3526 provides Universal Serial Bus standard power switch and over-current protection for all host port applications. The dual port device is ideal for Notebook and desktop PC's that supply power to more than one port.

A 1 ms delay on the fault flag output prevents erroneous overcurrent reporting caused by in-rush currents during hot-plug events.

The dual stage thermal protection circuit in the LM3526 provides individual protection to each switch and the entire device. In a short-circuit/over-current event, the switch dissipating excessive heat is turned off, allowing the second switch to continue to function uninterrupted.

The LM3526 accepts an input voltage between 2.7V and 5.5V allowing use as a device-based in-rush current limiter for 3.3V USB peripherals, as well as Root and Self-Powered Hubs at 5.5V. The Enable inputs accept both 3.3V and 5.0V logic thresholds.

The small size, low R_{ON} , and 1 ms fault flag delay make the LM3526 a good choice for root hubs as well as per-port power control in embedded and stand-alone hubs.

Features

- 1 ms fault flag delay filters Hot-Plug events
- Smooth turn-on eliminates in-rush induced voltage drop
- UL recognized component: REF# 205202
- 1A nominal short circuit output current protects PC power supplies
- Thermal shutdown protects device in direct short condition
- 500mA minimum continuous load current
- Small SO-8 package minimizes board space
- 2.7V to 5.5V input voltage range
- 140 mΩ Max. switch resistance
- 1 μA Max. standby current
- 200 μA Max. operating current
- Under-voltage lockout (UVLO)

Applications

- Universal Serial Bus (USB) Root Hubs including Desktop and Notebook PC
- USB Monitor Hubs
- Other Self-Powered USB Hub Devices
- High Power USB Devices Requiring In-rush Limiting
- General Purpose High Side Switch Applications

Typical Operating Circuit and Connection Diagram

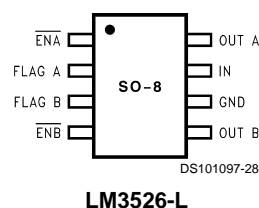
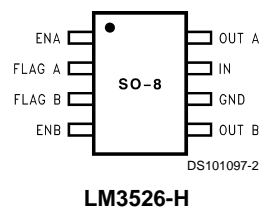
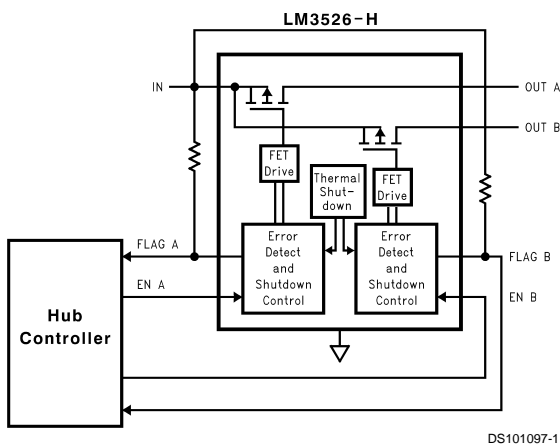

Ordering Information

Part Number	Enable, Delivery Option	Package Type
LM3526M-H	Active High Enable, 95 units per rail	SO-8, NS Package Number M08A
LM3526M-L	Active Low Enable, 95 units per rail	
LM3526MX-H	Active High Enable, 2500 units per reel	
LM3526MX-L	Active Low Enable, 2500 units per reel	

Absolute Maximum Ratings (Note 1)

If Military/Aerospace specified devices are required, please contact the National Semiconductor Sales Office/Distributors for availability and specifications.

Supply Voltage	-0.3V to 6V
Output Voltage	-0.3V to 6V
Voltage at All Other Pins	-0.3V to 5.5V
Power Dissipation ($T_A = 25^\circ\text{C}$) (Note 2)	700 mW
T_{JMAX} (Note 2)	160°C

Operating Ratings

Supply Voltage Range	2.7V to 5.5V
Operating Ambient Range	-40°C to 85°C
Operating Junction Temperature Range	-40°C to 125°C
Storage Temperature Range	-65°C to +150°C
Lead Temperature (Soldering, 5 seconds)	260°C
ESD Rating (Note 3)	2kV
ESD Rating Output Only	8kV

DC Electrical Characteristics

Limits in standard typeface are for $T_J = 25^\circ\text{C}$, and limits in **boldface** type apply over the full operating temperature range. Unless otherwise specified: $V_{IN} = 5.0\text{V}$, $V_{EN} = 0\text{V}$ (LM3526-L) or $V_{EN} = V_{IN}$ (LM3526-H).

Symbol	Parameter	Conditions	Min	Typ	Max	Units
R_{ON}	On Resistance	$V_{IN} = 5\text{V}$, $I_{OUT} = 500\text{mA}$, each switch		100	140	mΩ
		$V_{IN} = 2.7\text{V}$, $I_{OUT} = 500\text{mA}$, each switch		110	180	
I_{OUT}	OUT pins continuous output current	Each Output	0.5			A
I_{SC}	Short Circuit Output Current	Each Output (enable into Load) (Note 4)	0.5	1.2	1.9	A
		$V_{OUT} = 4.0\text{V}$ $V_{OUT} = 0.1\text{V}$		1	1.5	
OC_{THRESH}	Over-current Threshold			2.2	3.2	A
I_{LEAK}	OUT pins Output Leakage Current	$V_{EN} = V_{IN}$ (LM3526-L) $V_{EN} = 0\text{V}$ (LM3526-H)		0.01	10	μA
R_{FO}	FLAG Output Voltage	$I_{FO} = 10\text{ mA}$, $V_{IN} = 5.0\text{V}$		10	25	Ω
		$I_{FO} = 10\text{ mA}$, $V_{IN} = 3.3\text{V}$		11	35	
		$I_{FO} = 10\text{ mA}$, $V_{IN} = 2.7\text{V}$		12	40	
I_{EN}	\overline{EN}/EN Leakage Current	$V_{EN}/V_{EN} = 0\text{V}$ or $V_{EN}/V_{EN} = V_{IN}$	-0.5		0.5	μA
V_{IH}	\overline{EN}/EN Input Logic High	(Note 5)	2.4	1.9		V
V_{IL}	\overline{EN}/EN Input Logic Low	(Note 5)		1.7	0.8	V
V_{UVLO}	Under-Voltage Lockout Threshold			1.8		V
I_{DDOFF}	Supply Current	Switch-Off -40°C ≤ T_J ≤ 85°C		0.2	1 2	μA
I_{DDON}	Supply Current	Switch-On		115	200	μA
Th_{SD}	Over-temperature Shutdown Threshold	T_J Increasing, with no shorted output		150		°C
		T_J Increasing, with shorted output (s)		145		
		T_J Decreasing (Note 4)		135		
I_{FH}	Error Flag Leakage Current	$V_{flag} = 5\text{V}$		0.01	1	μA

Note 1: Absolute Maximum Ratings indicate limits beyond which damage to the device may occur. Electrical specifications do not apply when operating the device beyond its rated operating conditions.

Note 2: The maximum power dissipation must be derated at elevated temperatures and is dictated by T_{JMAX} (Maximum junction temperature), θ_{JA} (junction to ambient thermal resistance), and T_A (ambient temperature). The maximum allowable power dissipation at any temperature is $P_{DMAX} = (T_{JMAX} - T_A)/\theta_{JA}$ or the number given in the Absolute Maximum Ratings, whichever is lower. $\theta_{JA} = 150^\circ\text{C/W}$.

Note 3: The human body model is a 100 pF capacitor discharged through a 1.5 kΩ resistor into each pin. Enable pin ESD threshold is 1.7kV.

Note 4: Thermal Shutdown will protect the device from permanent damage.

Note 5: For LM3526-L, OFF is $\overline{EN} \geq 2.4\text{V}$ and ON is $\overline{EN} \leq 0.8\text{V}$. For LM3526-H, OFF is $EN \leq 0.8\text{V}$ and ON is $EN \geq 2.4\text{V}$.

AC Electrical Characteristics

Limits in standard typeface are for $T_J = 25^\circ\text{C}$, and limits in **boldface** type apply over the full operating temperature range. Unless otherwise specified: $V_{IN} = 5.0\text{V}$.

Symbol	Parameter	Conditions	Min	Typ	Max	Units
t_r	OUT Rise Time	$R_L = 10\Omega$		100		μs
t_f	OUT Fall Time	$R_L = 10\Omega$		5		μs
t_{ON}	Turn on Delay, $\overline{\text{EN}}$ to OUT	$R_L = 10\Omega$		150		μs
t_{OFF}	Turn off Delay, $\overline{\text{EN}}$ to OUT	$R_L = 10\Omega$		5		μs
t_{OC}	Over Current Flag Delay	$R_L = 0$		1		ms

Pin Description

Pin Number	Pin Name	Pin Function
1, 4	$\overline{\text{ENA}}$, $\overline{\text{ENB}}$ (LM3526-L) ENA, ENB (LM3526-H)	Enable (Input): Logic-compatible enable inputs.
2, 3	FLAG A FLAG B	Fault Flag (Output): Active-low, open-drain outputs. Indicates overcurrent, UVLO or thermal shutdown. *See application section for more information.
6	GND	Ground
7	IN	Supply Input: This pin is the input to the power switch and the supply voltage for the IC.
8, 5	OUT A OUT B	Switch Output: These pins are the outputs of the high side switch.

Typical Application Circuit

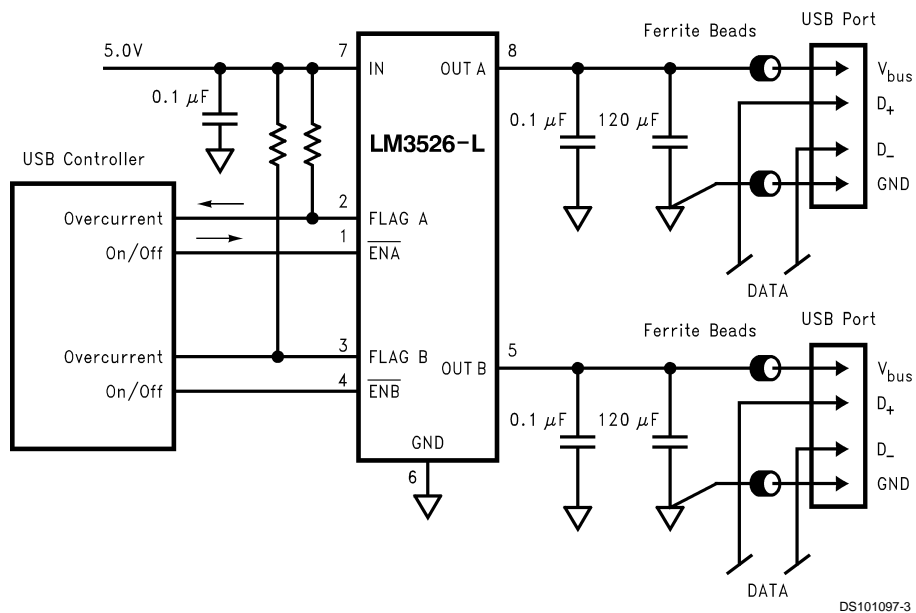

Typical Performance Characteristics $V_{IN} = 5.0V$, $I_L = 500\text{ mA}$, $T_A = 25^\circ\text{C}$ unless otherwise specified.

R_{ON} vs Temperature

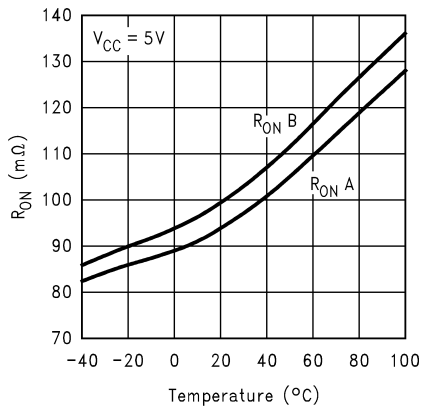

R_{ON} vs Temperature

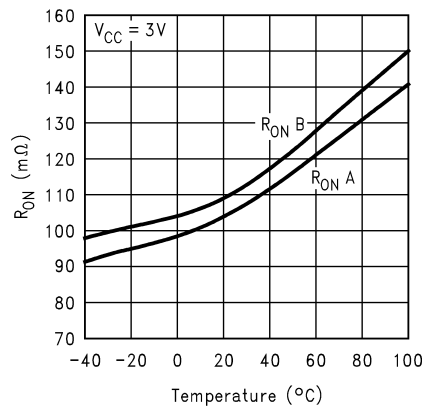

Quiescent Current vs Input Voltage

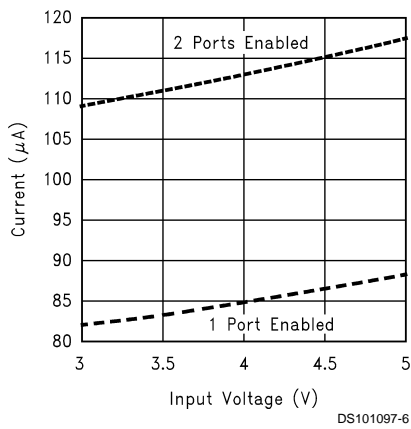

Quiescent Current vs Temperature

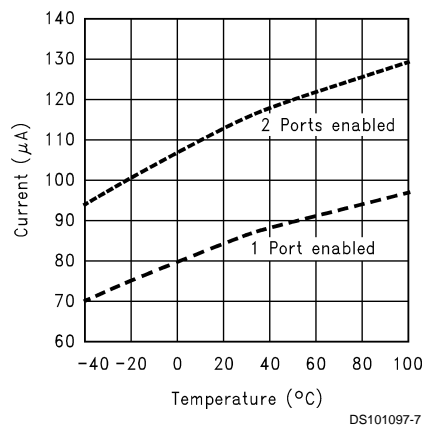

Current Limit vs Output Voltage

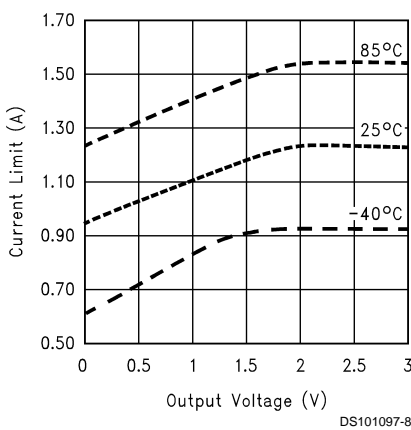

OC Threshold vs Temperature

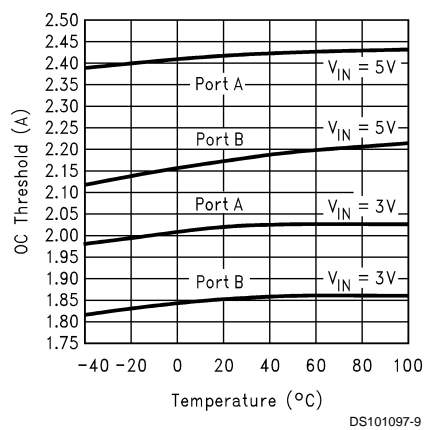

Typical Performance Characteristics $V_{IN} = 5.0V$, $I_L = 500\text{ mA}$, $T_A = 25^\circ\text{C}$ unless otherwise specified. (Continued)

Fault Flag Delay vs Temperature

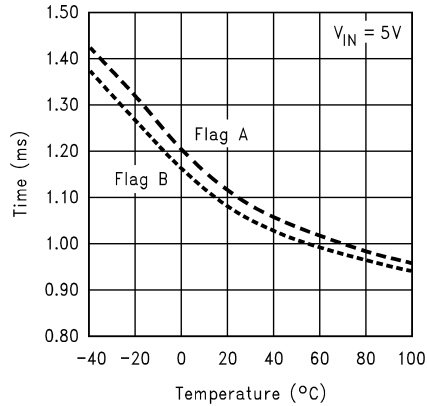

DS101097-35

Fault Flag Delay vs Temperature

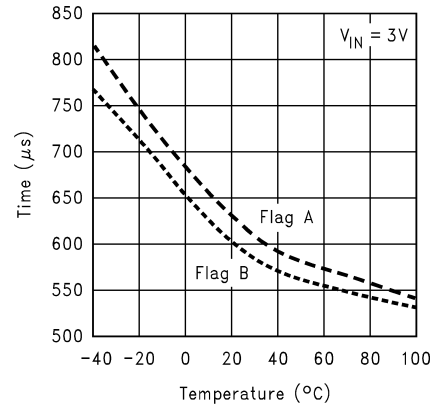

DS101097-36

Under Voltage Lockout (UVLO)

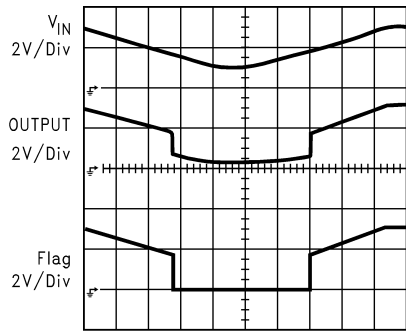

Time (100 ms/Div)

DS101097-34

Under Voltage Lockout Threshold vs Temperature

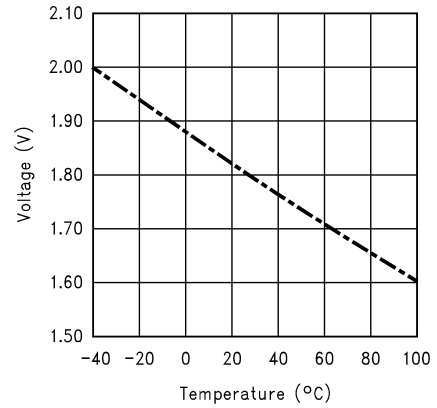

DS101097-37

Over Current/Current Limit Response*

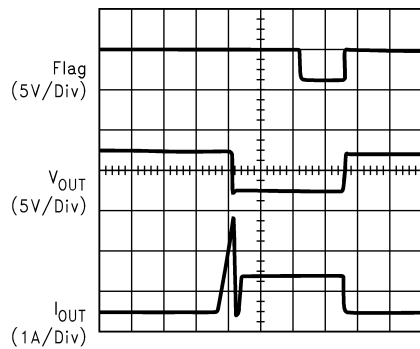

500 µs/Div

DS101097-10

Short Circuit Response with Thermal Cycling*

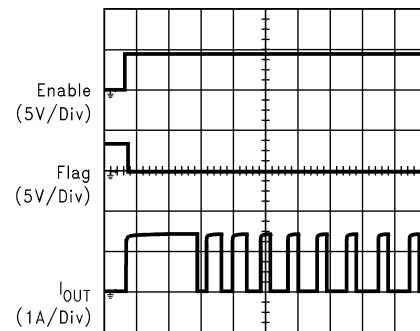

10 ms/Div

DS101097-11

* Output is shorted to Ground through a 100 mΩ resistor

Typical Performance Characteristics $V_{IN} = 5.0V$, $I_L = 500\text{ mA}$, $T_A = 25^\circ\text{C}$ unless otherwise specified. (Continued)

Turn-ON/OFF Response with 47Ω/10μF Load

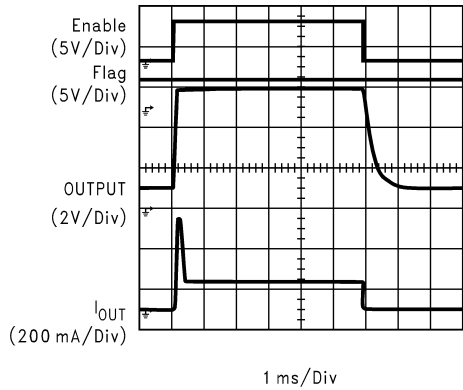

Turn-ON/OFF Response with 47Ω/150μF Load

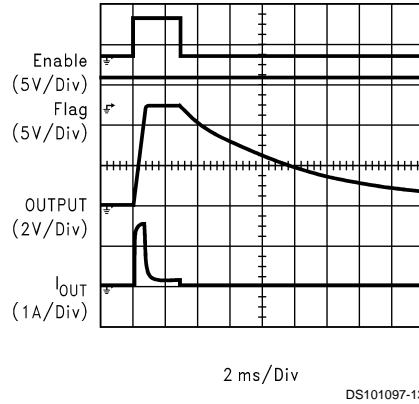

Thermal Shutdown Response (Port A output shorted*)

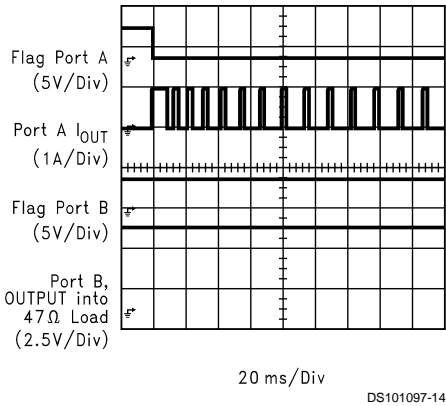

Thermal Shutdown Response (See Notes)

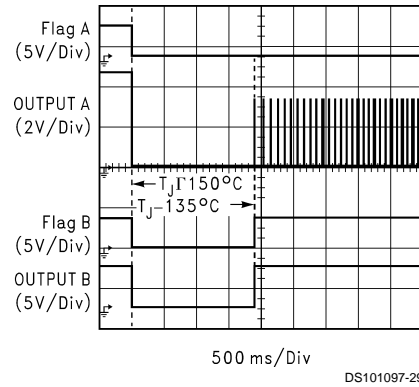

* Port A is shorted to GND through a 100 mΩ resistor

Enable into a short

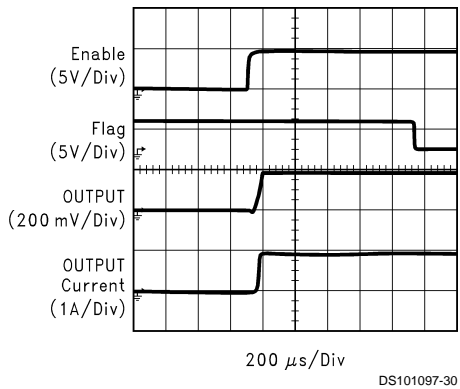

Functional Description

The LM3526-H and LM3526-L are high side P-Channel switches with active-high and active-low enable inputs, respectively. Fault conditions turn-off and inhibit turn-on of the output transistor and activate the open-drain error flag transistor sinking current to the ground.

INPUT AND OUTPUT

IN (Input) is the power supply connection to the control circuitry and the source of the output MOSFET.

OUT (Output) is the connection to the drain of the output MOSFET. In a typical application circuit, current flows through the switch from IN to OUT towards the load.

If V_{OUT} is greater than V_{IN} when the switch is enabled, current will flow from OUT to IN since the MOSFET is bidirectional.

THERMAL SHUTDOWN

The LM3526 is internally protected against excessive power dissipation by a two-stage thermal protection circuit. If the device temperature rises to approximately 145°C, the thermal shutdown circuitry turns off any switch that is current limited. Non-overloaded switches continue to function normally. If the die temperature rises above 150°C, both switches are turned off and both fault flag outputs are activated. Hysteresis ensures that a switch turned off by thermal shutdown will not be turned on again until the die temperature is reduced to 135°C. Shorted switches will continue to cycle off and on, due to the rising and falling die temperature, until the short is removed.

UNDERVOLTAGE LOCKOUT

UVLO prevents the MOSFET switch from turning on until input voltage exceeds 1.8V (typical).

If input voltage drops below 1.8V (typical), UVLO shuts off the MOSFET switch and signals the fault flag. UVLO functions only when device is enabled.

CURRENT LIMIT

The current limit circuit is designed to protect the system supply, the MOSFET switches and the load from damage caused by excessive currents. The current limit threshold is set internally to allow a minimum of 500 mA through the MOSFET but limits the output current to approximately 1.0A typical.

FAULT FLAG

The fault flag is an open-drain output capable of sinking 10 mA load current to typically 100 mV above ground.

A parasitic diode exists between the flag pins and V_{IN} pin. Pulling the flag pins to voltages higher than V_{IN} will forward bias this diode and will cause an increase in supply current. This diode will also clamp the voltage on the flag pins to a diode drop above V_{IN} .

The fault flag is active (pulled low) when any of the following conditions are present: under-voltage, current limit, or thermal shutdown.

A 1ms (typ.) delay in reporting the fault condition prevents erroneous fault flags and eliminates the need for an external RC delay network.

Application Information

FILTERING

The USB specification indicates that “no less than 120 μF tantalum capacitors” must be used on the output of each downstream port. This bulk capacitance provides the short-term transient current needed during a hot plug-in. Current surges caused by the input capacitance of the downstream device could generate undesirable EMI signals. Ferrite beads in series with all power and ground lines are recommended to eliminate or significantly reduce EMI.

In selecting a ferrite bead, the DC resistance of the wire used must be kept to a minimum to reduce the voltage drop.

A 0.01 μF ceramic capacitor is recommended on each port directly between the V_{BUS} and ground pins to prevent EMI damage to other components during the hot-detachment.

Adequate capacitance must be connected to the input of the device to limit the input voltage drop during a hot-plug event to less than 330 mV. For a few tens of μs , the host must supply the in-rush current to the peripheral, charging its bulk capacitance to V_{BUS} . This current is initially supplied by the input capacitor. A 33 μF 16V tantalum capacitor is recommended.

In choosing the capacitors, special attention must be paid to the Effective Series Resistance, ESR, of the capacitors to minimize the IR drop across the capacitor's ESR.

SOFT START

To eliminate the upstream voltage droop caused by the high in-rush current drawn by the output capacitors, the maximum in-rush current is internally limited to 1.5A.

TRANSIENT OVER-CURRENT DELAY

High transient current is also generated when the switch is enabled and large values of capacitance at the output have to be rapidly charged. The in-rush currents created could exceed the short circuit current limit threshold of the device forcing it into the current limit mode. The capacitor is charged with the maximum available short circuit current set by the LM3526. The duration of the in-rush current depends on the size of the output capacitance and load current. Since this is not a valid fault condition, the LM3526 delays the generation of the fault flag for 1 ms. If the condition persists due to other causes such as a short, a fault flag is generated after a 1 ms delay has elapsed.

The LM3526's 1 ms delay in issuing the fault flag is adequate for most applications. If longer delays are required, an RC filter as shown in *Figure 1* may be used.

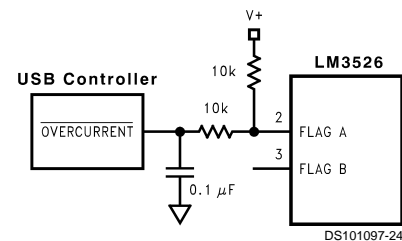

FIGURE 1.

Application Information (Continued)

PCB LAYOUT CONSIDERATIONS

In order to meet the USB requirements for voltage drop, droop and EMI, each component used in this circuit must be evaluated for its contribution to the circuit performance. The PCB layout rules and guidelines must be followed.

- Place the switch as close to the USB connector as possible. Keep all V_{BUS} traces as short as possible and use at least 50-mil, 1 ounce copper for all V_{BUS} traces. Solder plating the traces will reduce the trace resistance.

- Avoid vias as much as possible. If vias are used, use multiple vias in parallel and/or make them as large as possible.
- Place the output capacitor and ferrite beads as close to the USB connector as possible.
- If ferrite beads are used, use wires with minimum resistance and large solder pads to minimize connection resistance.

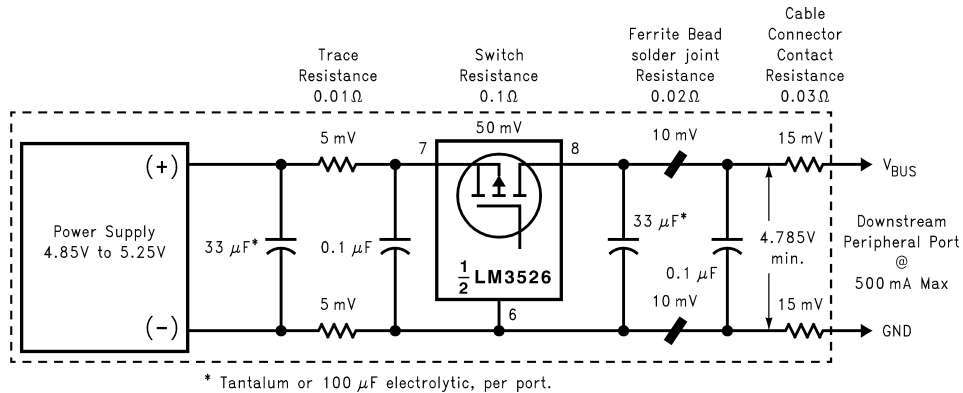

FIGURE 2. Self-Powered Hub Per-Port Voltage Drop

Typical Applications

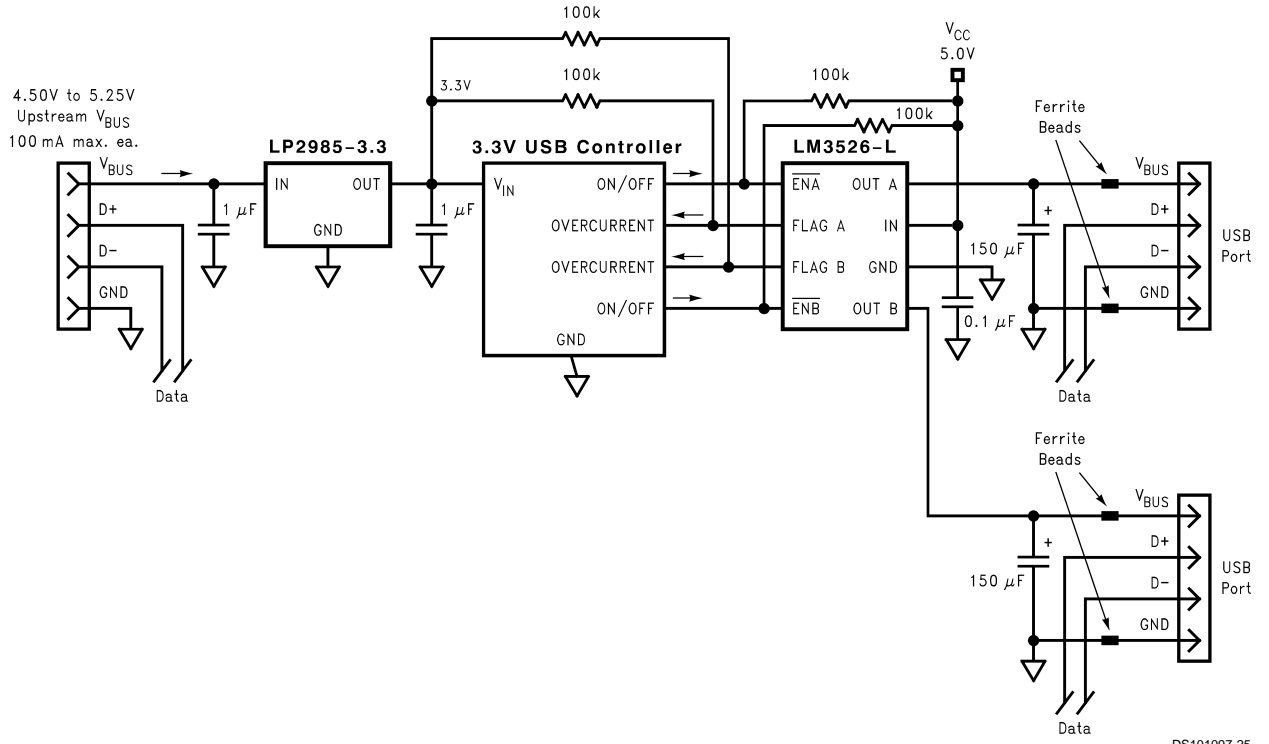

FIGURE 3. Dual-Port USB Self-Powered Hub

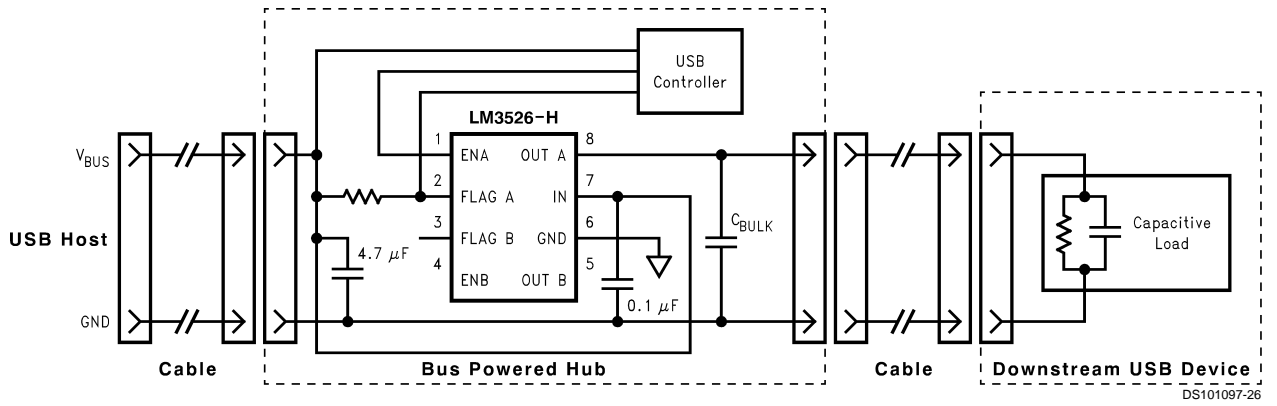

FIGURE 4. Soft-Start Application (Single port shown)

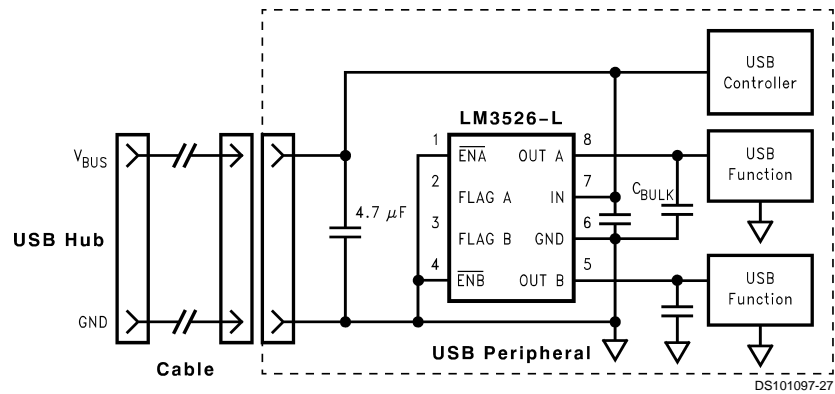
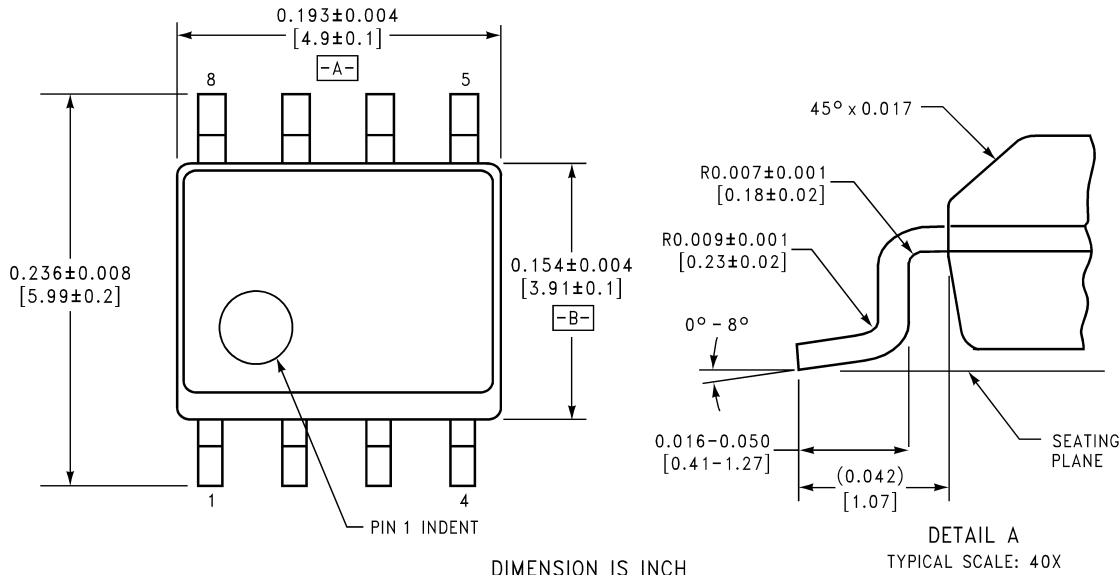

FIGURE 5. In-rush Current-limit Application

Physical Dimensions inches (millimeters) unless otherwise noted



DIMENSION IS INCH
VALUES IN [] ARE MILLIMETERS

DETAIL A
TYPICAL SCALE: 40X

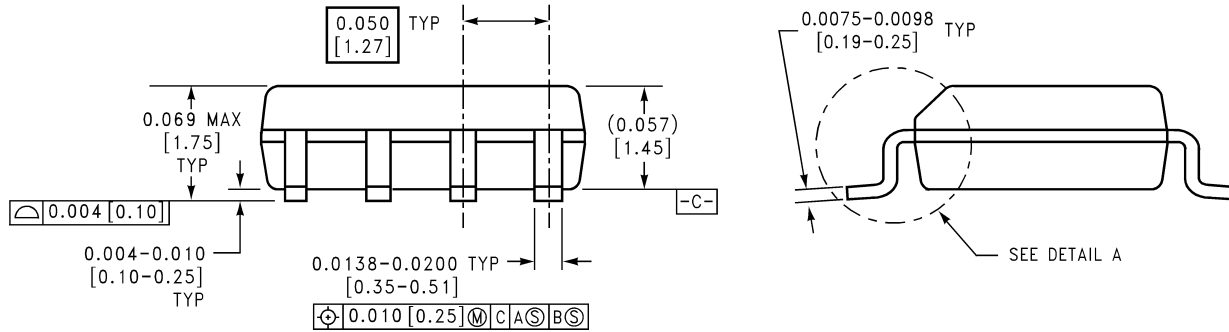

See Order Information Table
NS Package Number M08A

LIFE SUPPORT POLICY

NATIONAL'S PRODUCTS ARE NOT AUTHORIZED FOR USE AS CRITICAL COMPONENTS IN LIFE SUPPORT DEVICES OR SYSTEMS WITHOUT THE EXPRESS WRITTEN APPROVAL OF THE PRESIDENT AND GENERAL COUNSEL OF NATIONAL SEMICONDUCTOR CORPORATION. As used herein:

1. Life support devices or systems are devices or systems which, (a) are intended for surgical implant into the body, or (b) support or sustain life, and whose failure to perform when properly used in accordance with instructions for use provided in the labeling, can be reasonably expected to result in a significant injury to the user.
2. A critical component is any component of a life support device or system whose failure to perform can be reasonably expected to cause the failure of the life support device or system, or to affect its safety or effectiveness.

National Semiconductor Corporation
Americas
Tel: 1-800-272-9959
Fax: 1-800-737-7018
Email: support@nsc.com
www.national.com

National Semiconductor Europe
Fax: +49 (0) 180-530 85 86
Email: europe.support@nsc.com
Deutsch Tel: +49 (0) 69 9508 6208
English Tel: +44 (0) 870 24 0 2171
Français Tel: +33 (0) 1 41 91 8790

National Semiconductor Asia Pacific Customer Response Group
Tel: 65-2544466
Fax: 65-2504466
Email: ap.support@nsc.com

National Semiconductor Japan Ltd.
Tel: 81-3-5639-7560
Fax: 81-3-5639-7507